

tiespring®

USE THE BEST

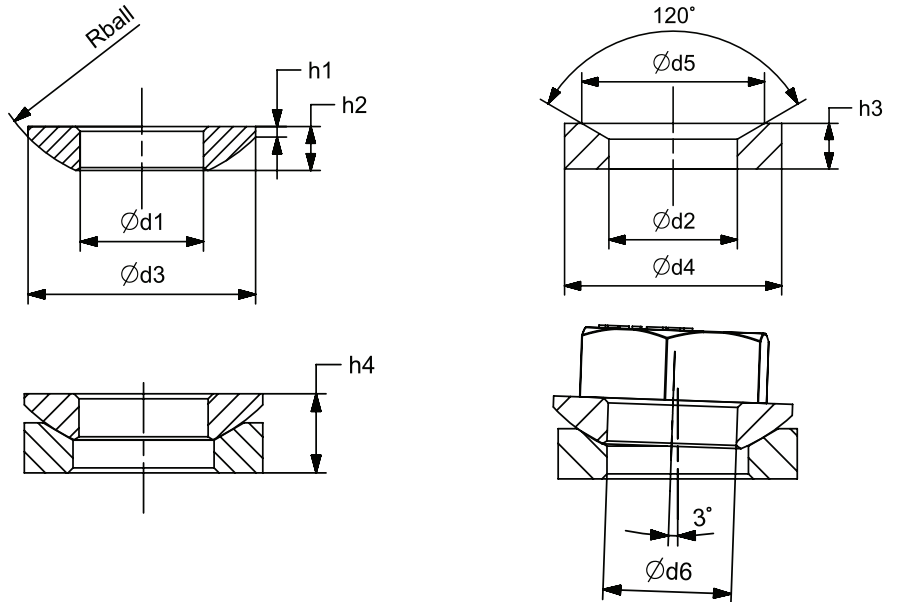
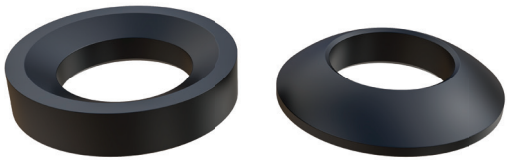

Technical Specifications

Product Code	Item Number	700303
d1 H13 Type C	Inner Diameter Conical Seat (mm)	10,50
d2 H13 Type D - Type G	Inner Diameter Spherical Washers (mm)	12,00
d3	Outer Diameter Conical Seat (mm)	21,00
d4 Type D	Outer Diameter Spherical Washers (mm)	21,00
d5		18,50
d6 Screw		M10
h1		0,80
h2	Material Thickness Conical Seat (mm)	4,00
h3 Type D	Material Thickness Spherical Washers (mm)	4,20
h4 Type D	Total Thickness (mm)	7,00
r	Ball Radius (mm)	15,00
	Transferable static bolt force kN max.	26,00

Standart

DIN 6319

Materials

Version C and D: case-hardened steel (hardening depth 0.2 - 0.4 mm), hardness (550 + 100) HV 10.

Stainless Steel AISI 316 A4 not hardened

Version G: hardened and tempered steel, hardness (350 + 80) HV 30.

Stainless Steel AISI 316 A4 not hardened